

MC5 to MC75 Miniature Shock Absorbers

Shock absorbers in miniature format

Self-compensating

Energy capacity 0.68 Nm/cycle to 9 Nm/cycle

Stroke 4 mm to 10 mm

MC5EUM

MC9EUM

MC10EUM

MC25EUM

MC30EUM

MC75EUM

The identification numbers listed are the respective standard units of the corresponding shock absorber series. Special types can have deviating identification numbers.

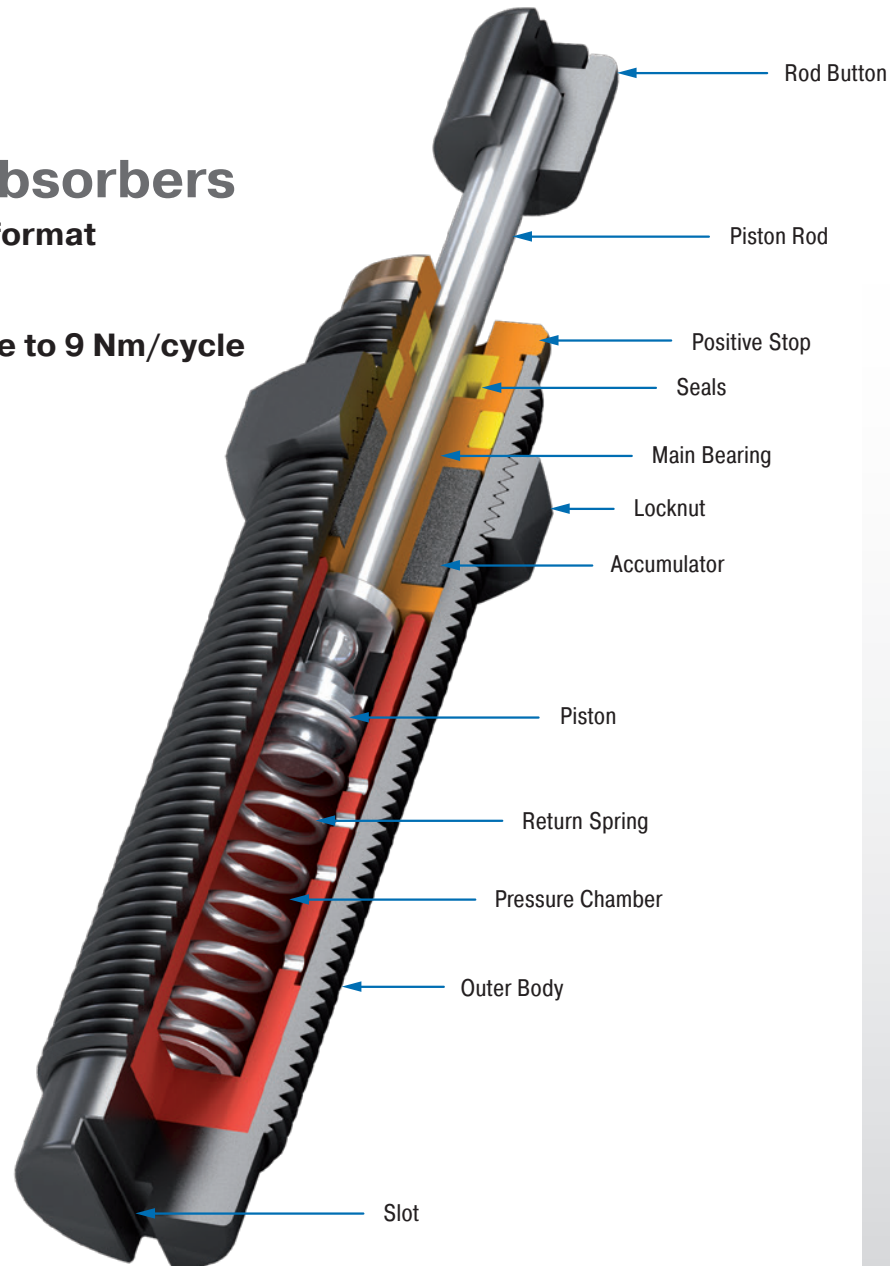

Table of contents	Page
General instructions.....	2
Safety information	2
Intended use.....	2
Description and function.....	2
Calculation and design	2
Delivery and storage	2
Maintenance and care	2
Disassembly and disposal.....	2
Mounting instructions.....	3 - 8
Warranty	9
Expected service life	9
Technical data.....	9

General instructions

This manual is for the disruption-free use of the product types listed on page 1; its compliance is a prerequisite for the fulfilment of any warranty claims.

Therefore, make sure to read this manual before use.

Please always maintain the specified limits from the performance table (technical data). Take into account the predominant environmental conditions and restrictions. Note the regulations of the trade association, TÜV or corresponding national, international and European regulations. Installation and commissioning only according to mounting instructions.

Safety information

WARNING

! If ACE miniature shock absorbers are used where a failure of the product could lead to personal injuries and/or material damage, additional safety elements must be implemented.

! Free-moving masses can lead to injuries by crushing during installation of the shock absorber. Secure moving masses against inadvertent starting with suitable safety precautions before installing the shock absorbers.

Intended use

ACE miniature shock absorbers are used wherever moving masses are to be slowed down in a defined end position. The industrial shock absorbers are designed for force capacity in an axial direction. Within the permissible load limits the industrial shock absorber also acts as a stop.

Description and function

The ACE miniature shock absorbers MC5 to MC75 are maintenance-free, ready-to-install hydraulic components with numerous metering openings.

During the slowing down process the moving mass moves with kinetic energy and, if necessary, an additional drive energy in the axial direction of the piston rod with a defined impact velocity against the rod end button of the shock absorber. Alternatively, numerous shock absorbers can also be used in parallel. During the initiated slowing down process the piston rod is pushed into the shock absorber. The hydraulic oil located before the piston is displaced through all metering orifices at the same time. The number of effective metering openings reduces in proportion to the driven stroke. The retraction speed reduces.

Note: Types MC5, MC9, MC10 and MC25 each work with only one metering orifice. The dynamic pressure applied in front of

the piston corresponds to the counterforce applied by the shock absorber and remains approximately constant over the entire stroke. A requirement for a constant rate of deceleration is the correct calculation of the industrial shock absorber and therefore the correct selection of the right metering orifice pattern or the right hardness level of the shock absorber. The hardnesses are divided into effective mass ranges, which can be found in the performance table (technical data).

General Function

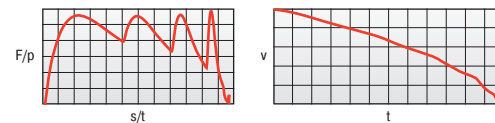

F = Force (N) p = Internal pressure (bar) s = Stroke (m)
t = Deceleration time (s) v = Velocity (m/s)

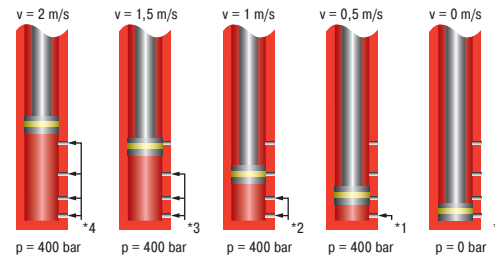

* The load velocity reduces continuously as you travel through the stroke due to the reduction in the number of metering orifices (*) in action. The internal pressure remains essentially constant and thus the Force vs. stroke curve remains linear.

Calculation and design

In order to ensure an optimum, fault-free and durable function of the industrial shock absorbers they must be correctly dimensioned and designed. The following parameters must be known and used in the calculation:

- Moving mass [kg]
- Impact velocity of the mass into the shock absorber(s) [m/s]
- Additionally acting propelling force, propelling power or propelling torque [N, kW, Nm]
- Number of shock absorbers acting in parallel [n]
- Number of strokes or cycles per hour [1/h]

The correct size of the shock absorbers can be determined with the ACE online calculation programme at www.ace-ace.de. You can also send us the completed online form via e-mail for checking.

Or make use of our free calculation service by phoning: +49 (0)2173 - 9226-20.

WARNING

! The dampers must be dimensioned in such a way that the calculated values do not exceed the maximum values of the respective performance table (technical data):

W_j [Nm/cycle]

W_i [Nm/h]

Effective weight m_e

Max. side load angle [°]

! For a correct damping design the shock absorber must represent the only braking system. Additional braking systems, such as a pneumatic end position damping length, must not overlap with the end position damping length by the shock absorber and must be disabled.

Delivery and storage

- After delivery please check the shock absorber for any damage.
- The shock absorber can become damaged if it falls. Carefully remove shock absorber from the packaging.
- Shock absorbers can generally be stored in any position.
- Storage in the original packaging is preferred.
- Always store shock absorbers in a dry place in order to avoid oxidation.
- The recommended maximum storage time is three years.

Maintenance and care

Regularly check the shock absorbers for oil loss, return of the piston rod and external damage.

Shock absorbers are machine elements that are subject to continuous wear. Increased service life results in reduced damping effect. If this is no longer sufficient, the shock absorbers must be replaced or exchanged as appropriate.

Disassembly and disposal

Take account of environmental protection (recovery of problematic substances) during disposal of the shock absorber.

The MC miniature shock absorbers are filled with oil. The corresponding data sheets are available for the respective types on request. Faulty dampers can be sent to our service department for determination of the cause of failure.

Mounting instructions and mounting accessories

Installation instructions

Before installation and use check whether the identification number on the damper or on the packaging matches the respective designation on the delivery note. Industrial shock absorbers are maintenance-free and ready to install.

Operating temperature range: 0 °C to 66 °C

Mounting: As required but always in such a way that the entire damper stroke is used. The dampers must always be mounted in such a way that the forces are introduced centrally over the piston rod. The maximum permissible side load angle of 2° must not be exceeded. If there is a side load angle, it generally leads to a reduction in service life. In the case of maximum permissible values being exceeded a side load adapter must be used.

M5x0.5 mounting accessories

MC5







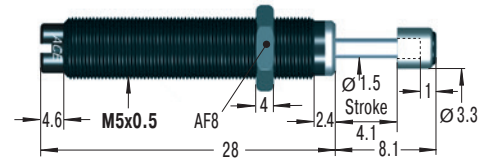

Before installation check whether the identification number on the packaging matches the respective designation on the delivery note.

Note the dimensioning for mounting when using accessory parts. Bolts for fitting of accessories are not included.

If you have any questions, please phone +49 (0)2173 - 9226-20 for free advice.

When using accessory parts and mounting elements also note the mounting instructions for accessories delivered separately.



WARNING	
	Temperature effect: The W_d and m_e values given in the performance table (see manual or catalogue) are valid for room temperature. Deviating values apply to higher temperatures.
	During installation of the dampers moving masses can lead to injuries due to inadvertent starting. Secure moving masses against inadvertent moving.
	The dampers may be unsuitable for use and have an insufficient damping effect. Check the specific suitability of the dampers before installation.
	If operated outside of the operating temperature range, the damper can lose its function. Operating temperature range must be maintained. Do not paint dampers due to heat emission.
	Fluids, gases and dirt particles in the surrounding area can attack or destroy the seal system of the damper and cause it to fail. Protect or encapsulate piston rod and seal system from external materials in the surrounding area.
	Damage to the piston rod surface can destroy the seal system. Do not grease, oil piston rod etc. and protect against dirt particles.
	The piston rod can be torn from the damper. Do not load the piston rod with tensile stress.
	Damper can tear off upon impact. Always lay out the connection structure in such a way that the maximum occurring forces can be absorbed with sufficient safety. The maximum reacting forces listed in the calculation range may deviate from the actually occurring reacting forces, as these are based on theoretical values.

MB5SC2

Mounting block

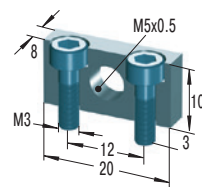

Mounting types

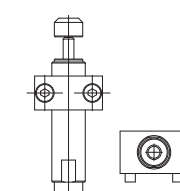
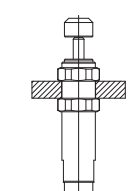
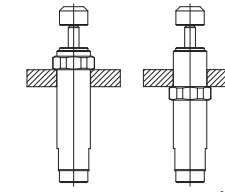
<p>Use of mounting block MB5SC2</p>  <p>Torque: KM5 = 1.3-1.5 Nm</p>	<p>Mounting of damper in borehole with two locknuts</p>  <p>Torque: KM5 = 1.3-1.5 Nm</p>
<p>Screwing the damper into a threaded hole with additional locknut</p>  <p>Torque: KM5 = 1.3-1.5 Nm</p> <p>Minimum screw-in depth: 1.5 x bolt diameter</p>	

Commissioning

- After installation, start a test run of the moving mass at reduced operating speed to begin with.

During the test run

- Gradually accelerate the load capacity up to the subsequent operating speed. You can find this in the calculation for your application. In the correct final setting, the piston rod of the shock absorber reaches the end position (positive stop) without a hard stop.

Packaging disposal

Please dispose of the transportation packaging in an environmentally-friendly manner. Recycling packaging materials saves raw materials and reduces waste. The packaging materials do not contain any prohibited materials.

Mounting instructions and mounting accessories

Installation instructions

Before installation and use check whether the identification number on the damper or on the packaging matches the respective designation on the delivery note. Industrial shock absorbers are maintenance-free and ready to install.

Operating temperature range: 0 °C to 66 °C

Mounting: As required but always in such a way that the entire damper stroke is used. The dampers must always be mounted in such a way that the forces are introduced centrally over the piston rod. The maximum permissible side load angle of 2° must not be exceeded. If there is a side load angle, it generally leads to a reduction in service life. In the case of maximum permissible values being exceeded a side load adapter must be used.

M6x0.5 mounting accessories

MC9







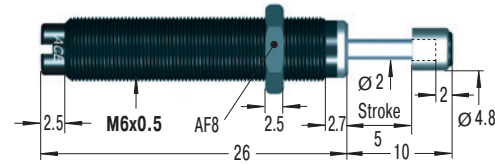

Before installation check whether the identification number on the packaging matches the respective designation on the delivery note.

Note the dimensioning for mounting when using accessory parts. Bolts for fitting of accessories are not included.

If you have any questions, please phone +49 (0)2173 - 9226-20 for free advice.

When using accessory parts and mounting elements also note the mounting instructions for accessories delivered separately.



WARNING	
	Temperature effect: The W_d and m_e values given in the performance table (see manual or catalogue) are valid for room temperature. Deviating values apply to higher temperatures.
	During installation of the dampers moving masses can lead to injuries due to inadvertent starting. Secure moving masses against inadvertent moving.
	The dampers may be unsuitable for use and have an insufficient damping effect. Check the specific suitability of the dampers before installation.
	If operated outside of the operating temperature range, the damper can lose its function. Operating temperature range must be maintained. Do not paint dampers due to heat emission.
	Fluids, gases and dirt particles in the surrounding area can attack or destroy the seal system of the damper and cause it to fail. Protect or encapsulate piston rod and seal system from external materials in the surrounding area.
	Damage to the piston rod surface can destroy the seal system. Do not grease, oil piston rod etc. and protect against dirt particles.
	The piston rod can be torn from the damper. Do not load the piston rod with tensile stress.
	Damper can tear off upon impact. Always lay out the connection structure in such a way that the maximum occurring forces can be absorbed with sufficient safety. The maximum reacting forces listed in the calculation range may deviate from the actually occurring reacting forces, as these are based on theoretical values.

MB6SC2

Mounting block

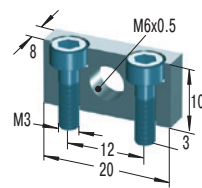

RF6

Rectangular flange

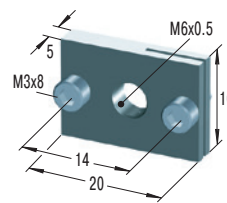

Mounting types

Use of mounting block MBSC2

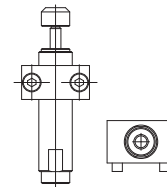

Torque:
KM6 = 1.3-1.5 Nm

Use of rectangular flange RF

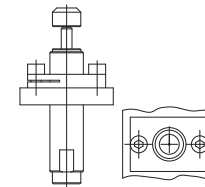

Screwing the damper into a threaded hole with additional locknut

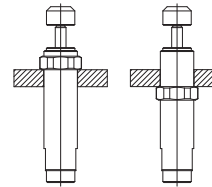

Torque:
KM6 = 1.3-1.5 Nm

Minimum screw-in depth:
1.5 x bolt diameter

Mounting of damper in borehole with two locknuts

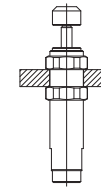

Torque:
KM6 = 1.3-1.5 Nm

Commissioning

- After installation, start a test run of the moving mass at reduced operating speed to begin with.

During the test run

- Gradually accelerate the load capacity up to the subsequent operating speed. You can find this in the calculation for your application. In the correct final setting, the piston rod of the shock absorber reaches the end position (positive stop) without a hard stop.

Packaging disposal

Please dispose of the transportation packaging in an environmentally-friendly manner. Recycling packaging materials saves raw materials and reduces waste. The packaging materials do not contain any prohibited materials.

Mounting instructions and mounting accessories

Installation instructions

Before installation and use check whether the identification number on the damper or on the packaging matches the respective designation on the delivery note. Industrial shock absorbers are maintenance-free and ready to install.

Operating temperature range: 0 °C to 66 °C

Mounting: As required but always in such a way that the entire damper stroke is used. The dampers must always be mounted in such a way that the forces are introduced centrally over the piston rod. The maximum permissible side load angle of 2° must not be exceeded. If there is a side load angle, it generally leads to a reduction in service life. In the case of maximum permissible values being exceeded a side load adapter must be used.

M8x1 mounting accessories

MC10







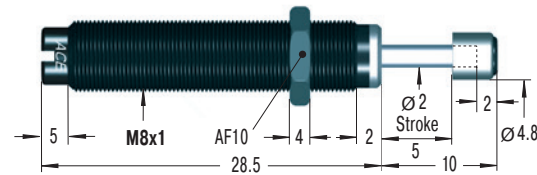

Before installation check whether the identification number on the packaging matches the respective designation on the delivery note.

Note the dimensioning for mounting when using accessory parts. Bolts for fitting of accessories are not included.

If you have any questions, please phone +49 (0)2173 - 9226-20 for free advice.

When using accessory parts and mounting elements also note the mounting instructions for accessories delivered separately.



WARNING	
	Temperature effect: The W_d and m_e values given in the performance table (see manual or catalogue) are valid for room temperature. Deviating values apply to higher temperatures.
	During installation of the dampers moving masses can lead to injuries due to inadvertent starting. Secure moving masses against inadvertent moving.
	The dampers may be unsuitable for use and have an insufficient damping effect. Check the specific suitability of the dampers before installation.
	If operated outside of the operating temperature range, the damper can lose its function. Operating temperature range must be maintained. Do not paint dampers due to heat emission.
	Fluids, gases and dirt particles in the surrounding area can attack or destroy the seal system of the damper and cause it to fail. Protect or encapsulate piston rod and seal system from external materials in the surrounding area.
	Damage to the piston rod surface can destroy the seal system. Do not grease, oil piston rod etc. and protect against dirt particles.
	The piston rod can be torn from the damper. Do not load the piston rod with tensile stress.
	Damper can tear off upon impact. Always lay out the connection structure in such a way that the maximum occurring forces can be absorbed with sufficient safety. The maximum reacting forces listed in the calculation range may deviate from the actually occurring reacting forces, as these are based on theoretical values.

MB8SC2

Mounting block

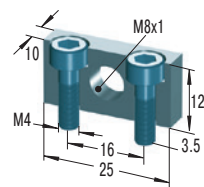

RF8

Rectangular flange

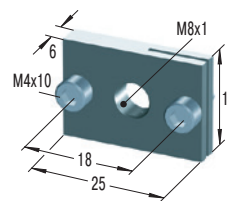

Mounting types

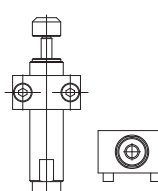
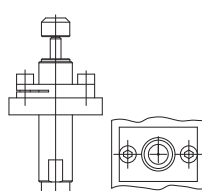
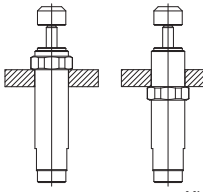
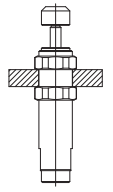
<p>Use of mounting block MBSC2</p>  <p>Torque: KM8 = 1.3-1.5 Nm</p>	<p>Use of rectangular flange RF</p> 
<p>Screwing the damper into a threaded hole with additional locknut</p>  <p>Torque: KM8 = 1.3-1.5 Nm</p> <p>Minimum screw-in depth: 1.5 x bolt diameter</p>	<p>Mounting of damper in borehole with two locknuts</p>  <p>Torque: KM8 = 1.3-1.5 Nm</p>

Commissioning

- After installation, start a test run of the moving mass at reduced operating speed to begin with.

During the test run

- Gradually accelerate the load capacity up to the subsequent operating speed. You can find this in the calculation for your application. In the correct final setting, the piston rod of the shock absorber reaches the end position (positive stop) without a hard stop.

Packaging disposal

Please dispose of the transportation packaging in an environmentally-friendly manner. Recycling packaging materials saves raw materials and reduces waste. The packaging materials do not contain any prohibited materials.

Mounting instructions and mounting accessories

Installation instructions

Before installation and use check whether the identification number on the damper or on the packaging matches the respective designation on the delivery note. Industrial shock absorbers are maintenance-free and ready to install.

Operating temperature range: 0 °C to 66 °C

Mounting: As required but always in such a way that the entire damper stroke is used. The dampers must always be mounted in such a way that the forces are introduced centrally over the piston rod. The maximum permissible side load angle of 2° must not be exceeded. If there is a side load angle, it generally leads to a reduction in service life. In the case of maximum permissible values being exceeded a side load adapter must be used.

M10x1 mounting accessories

MC25







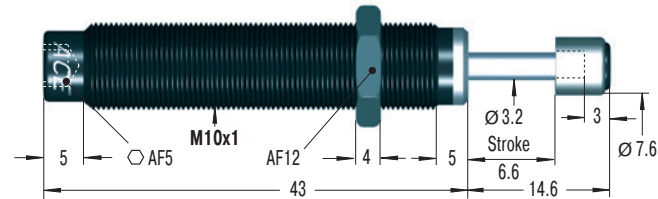

Before installation check whether the identification number on the packaging matches the respective designation on the delivery note.

Note the dimensioning for mounting when using accessory parts. Bolts for fitting of accessories are not included.

If you have any questions, please phone +49 (0)2173 - 9226-20 for free advice.

When using accessory parts and mounting elements also note the mounting instructions for accessories delivered separately.



WARNING	
	Temperature effect: The W_d and m_e values given in the performance table (see manual or catalogue) are valid for room temperature. Deviating values apply to higher temperatures.
	During installation of the dampers moving masses can lead to injuries due to inadvertent starting. Secure moving masses against inadvertent moving.
	The dampers may be unsuitable for use and have an insufficient damping effect. Check the specific suitability of the dampers before installation.
	If operated outside of the operating temperature range, the damper can lose its function. Operating temperature range must be maintained. Do not paint dampers due to heat emission.
	Fluids, gases and dirt particles in the surrounding area can attack or destroy the seal system of the damper and cause it to fail. Protect or encapsulate piston rod and seal system from external materials in the surrounding area.
	Damage to the piston rod surface can destroy the seal system. Do not grease, oil piston rod etc. and protect against dirt particles.
	The piston rod can be torn from the damper. Do not load the piston rod with tensile stress.
	Damper can tear off upon impact. Always lay out the connection structure in such a way that the maximum occurring forces can be absorbed with sufficient safety. The maximum reacting forces listed in the calculation range may deviate from the actually occurring reacting forces, as these are based on theoretical values.

MB10SC2

Mounting block

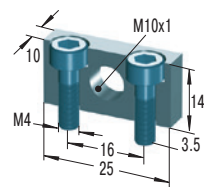

RF10

Rectangular flange

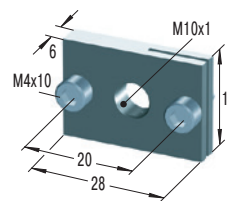

UM10

Universal mount

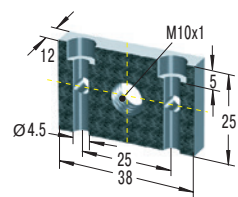

Mounting types

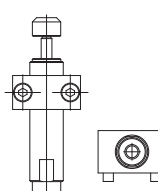
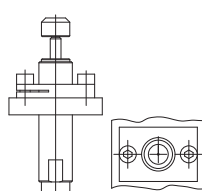
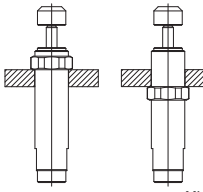
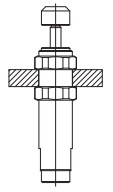
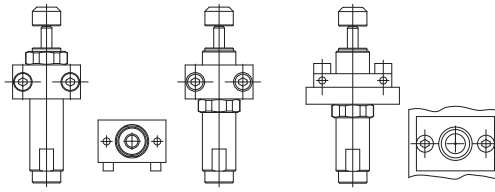
<p>Use of mounting block MBSC2</p>  <p>Torque: KM10 = 4.0-4.3 Nm</p>	<p>Use of rectangular flange RF</p> 
<p>Screwing the damper into a threaded hole with additional locknut</p>  <p>Torque: KM10 = 4.0-4.3 Nm</p> <p>Minimum screw-in depth: 1.5 x bolt diameter</p>	<p>Mounting of damper in borehole with two locknuts</p>  <p>Torque: KM10 = 4.0-4.3 Nm</p>
<p>Use of universal mount UM</p>  <p>Torque: KM10 = 4.0-4.3 Nm</p>	

Commissioning

- After installation, start a test run of the moving mass at reduced operating speed to begin with.

During the test run

- Gradually accelerate the load capacity up to the subsequent operating speed. You can find this in the calculation for your application. In the correct final setting, the piston rod of the shock absorber reaches the end position (positive stop) without a hard stop.

Packaging disposal

Please dispose of the transportation packaging in an environmentally-friendly manner. Recycling packaging materials saves raw materials and reduces waste. The packaging materials do not contain any prohibited materials.

Mounting instructions and mounting accessories

Installation instructions

Before installation and use check whether the identification number on the damper or on the packaging matches the respective designation on the delivery note. Industrial shock absorbers are maintenance-free and ready to install.

Operating temperature range: 0 °C to 66 °C

Mounting: As required but always in such a way that the entire damper stroke is used. The dampers must always be mounted in such a way that the forces are introduced centrally over the piston rod. The maximum permissible side load angle of 2° must not be exceeded. If there is a side load angle, it generally leads to a reduction in service life. In the case of maximum permissible values being exceeded a side load adapter must be used.

M8x1 mounting accessories

MC30







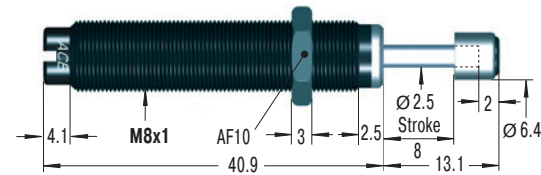

Before installation check whether the identification number on the packaging matches the respective designation on the delivery note.

Note the dimensioning for mounting when using accessory parts. Bolts for fitting of accessories are not included.

If you have any questions, please phone +49 (0)2173 - 9226-20 for free advice.

When using accessory parts and mounting elements also note the mounting instructions for accessories delivered separately.



WARNING	
	Temperature effect: The W_d and m_e values given in the performance table (see manual or catalogue) are valid for room temperature. Deviating values apply to higher temperatures.
	During installation of the dampers moving masses can lead to injuries due to inadvertent starting. Secure moving masses against inadvertent moving.
	The dampers may be unsuitable for use and have an insufficient damping effect. Check the specific suitability of the dampers before installation.
	If operated outside of the operating temperature range, the damper can lose its function. Operating temperature range must be maintained. Do not paint dampers due to heat emission.
	Fluids, gases and dirt particles in the surrounding area can attack or destroy the seal system of the damper and cause it to fail. Protect or encapsulate piston rod and seal system from external materials in the surrounding area.
	Damage to the piston rod surface can destroy the seal system. Do not grease, oil piston rod etc. and protect against dirt particles.
	The piston rod can be torn from the damper. Do not load the piston rod with tensile stress.
	Damper can tear off upon impact. Always lay out the connection structure in such a way that the maximum occurring forces can be absorbed with sufficient safety. The maximum reacting forces listed in the calculation range may deviate from the actually occurring reacting forces, as these are based on theoretical values.

MB8SC2

Mounting block

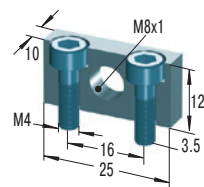

RF8

Rectangular flange

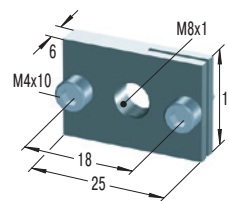

Mounting types

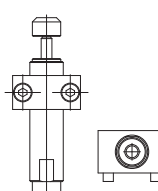
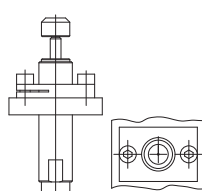
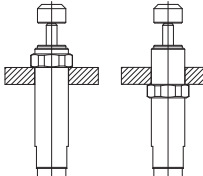
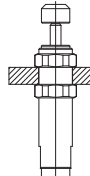
<p>Use of mounting block MBSC2</p>  <p>Torque: KM8 = 4.0-4.3 Nm</p>	<p>Use of rectangular flange RF</p> 
<p>Screwing the damper into a threaded hole with additional locknut</p>  <p>Torque: KM8 = 4.0-4.3 Nm</p> <p>Minimum screw-in depth: 1.5 x bolt diameter</p>	<p>Mounting of damper in borehole with two locknuts</p>  <p>Torque: KM8 = 4.0-4.3 Nm</p>

Commissioning

- After installation, start a test run of the moving mass at reduced operating speed to begin with.

During the test run

- Gradually accelerate the load capacity up to the subsequent operating speed. You can find this in the calculation for your application. In the correct final setting, the piston rod of the shock absorber reaches the end position (positive stop) without a hard stop.

Packaging disposal

Please dispose of the transportation packaging in an environmentally-friendly manner. Recycling packaging materials saves raw materials and reduces waste. The packaging materials do not contain any prohibited materials.

Mounting instructions and mounting accessories

Installation instructions

Before installation and use check whether the identification number on the damper or on the packaging matches the respective designation on the delivery note. Industrial shock absorbers are maintenance-free and ready to install.

Operating temperature range: 0 °C to 66 °C

Mounting: As required but always in such a way that the entire damper stroke is used. The dampers must always be mounted in such a way that the forces are introduced centrally over the piston rod. The maximum permissible side load angle of 2° must not be exceeded. If there is a side load angle, it generally leads to a reduction in service life. In the case of maximum permissible values being exceeded a side load adapter must be used.

M12x1 mounting accessories

MC75







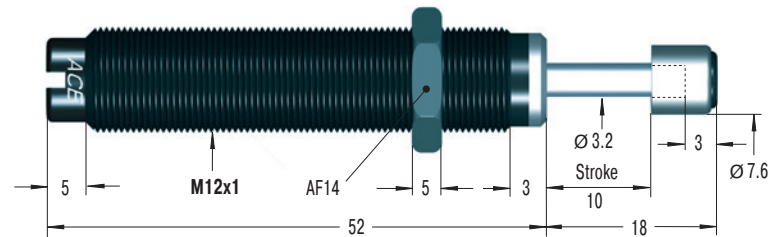

Before installation check whether the identification number on the packaging matches the respective designation on the delivery note.

Note the dimensioning for mounting when using accessory parts. Bolts for fitting of accessories are not included.

If you have any questions, please phone +49 (0)2173 - 9226-20 for free advice.

When using accessory parts and mounting elements also note the mounting instructions for accessories delivered separately.



WARNING	
	Temperature effect: The W_d and m_e values given in the performance table (see manual or catalogue) are valid for room temperature. Deviating values apply to higher temperatures.
	During installation of the dampers moving masses can lead to injuries due to inadvertent starting. Secure moving masses against inadvertent moving.
	The dampers may be unsuitable for use and have an insufficient damping effect. Check the specific suitability of the dampers before installation.
	If operated outside of the operating temperature range, the damper can lose its function. Operating temperature range must be maintained. Do not paint dampers due to heat emission.
	Fluids, gases and dirt particles in the surrounding area can attack or destroy the seal system of the damper and cause it to fail. Protect or encapsulate piston rod and seal system from external materials in the surrounding area.
	Damage to the piston rod surface can destroy the seal system. Do not grease, oil piston rod etc. and protect against dirt particles.
	The piston rod can be torn from the damper. Do not load the piston rod with tensile stress.
	Damper can tear off upon impact. Always lay out the connection structure in such a way that the maximum occurring forces can be absorbed with sufficient safety. The maximum reacting forces listed in the calculation range may deviate from the actually occurring reacting forces, as these are based on theoretical values.

MB12

Clamp mount

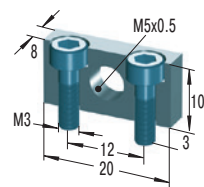

RF12

Rectangular flange

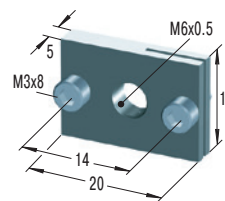

UM12

Universal mount

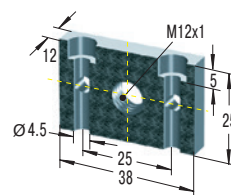

Mounting types

Use of clamp mount MB

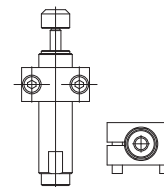

Use of rectangular flange RF

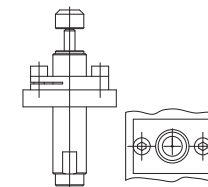

Screwing the damper into a threaded hole with additional locknut

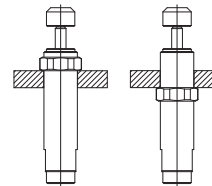

Torque:
KM12 = 5.0-5.4 Nm

Minimum screw-in depth:
1.5 x bolt diameter

Mounting of damper in borehole with two locknuts

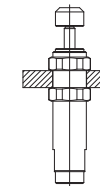

Torque:
KM12 = 5.0-5.4 Nm

Use of universal mount UM

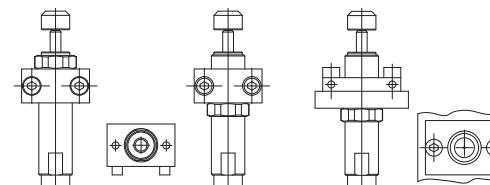

Torque:
KM12 = 5.0-5.4 Nm

Commissioning

- After installation, start a test run of the moving mass at reduced operating speed to begin with.

During the test run

- Gradually accelerate the load capacity up to the subsequent operating speed. You can find this in the calculation for your application. In the correct final setting, the piston rod of the shock absorber reaches the end position (positive stop) without a hard stop.

Packaging disposal

Please dispose of the transportation packaging in an environmentally-friendly manner. Recycling packaging materials saves raw materials and reduces waste. The packaging materials do not contain any prohibited materials.

Manual

Warranty

Fundamentally, all modifications to the product by third parties lead to exclusion from the warranty.

Obvious defects must be reported to the vendor in writing immediately after delivery, no later than one week, but in any case before processing or installation, otherwise the assertion of a warranty claim is excluded. A timely dispatch is sufficient to keep the term.

The vendor is to be given an opportunity to check on site. If the complaint is justified the vendor offers warranty by repair or replacement at its own discretion. If the rectification fails, the buyer may choose to demand reduction of payment or cancellation of the contract. If there is only a minor lack of conformity, particularly with only minor defects, the buyer nevertheless has a right of withdrawal.

If, after failed rectification, the buyer chooses to cancel the contract due to a defect of title or material defect, they are not entitled to additionally claim for damages.

If, after failed fulfilment, the buyer chooses compensation, the goods remain with the buyer, if this is reasonable. The compensation is limited to the difference between the purchase price and the value of the defective item. This does not apply if the vendor maliciously causes the breach of contract.

The quality of the goods is only considered as agreed upon with the product description of the vendor. Public statements, claims or advertising of the manufacturer do not represent an additional contractual specification of quality of the goods.

If the buyer receives defective mounting instructions, the buyer is only obligated to deliver defect-free mounting instructions and only if the defect to the mounting instructions prevents proper mounting.

The warranty period is two years and begins upon completion. Exchange and return of custom products are fundamentally excluded. The factory conditions of the manufacturing factory apply to parts not manufactured and processed by the vendor, which can be viewed by the orderer at the vendor at any time. Construction and installation parts are delivered according to the present standard of engineering.

Service life

In general industrial shock absorbers are machine elements that are subject to wear. Wear parts such as seals, pressure chambers and pistons are excluded from the general warranty. The wear of seals is largely dependent upon the operating conditions and the respective application and its operating parameters.

In general with this model of industrial shock absorber with grooved ring wiper seal system an average service life of three to five million load changes can be expected. Adverse environmental and operating conditions can significantly reduce the expected service life.

Performance data

TYPES	Max. Energy Capacity		Effective Weight		Return Force min. N	Return Force max. N	Return Time s	Side Load Angle max. °	Weight kg
	W ₃ Nm/cycle	W ₄ Nm/h	me min. kg	me max. kg					
MC5EUM-1-B	0.68	2,040	0.5	4.4	1	5	0.2	2	0.003
MC5EUM-2-B	0.68	2,040	3.8	10.8	1	5	0.2	2	0.003
MC5EUM-3-B	0.68	2,040	9.7	18.7	1	5	0.2	2	0.003
MC9EUM-1-B	1	2,000	0.6	3.2	2	4	0.3	2	0.004
MC9EUM-2-B	1	2,000	0.8	4.1	2	4	0.3	2	0.004
MC10EUM-L-B	1.25	4,000	0.3	2.7	2	4	0.6	3	0.007
MC10EUM-H-B	1.25	4,000	0.7	5	2	4	0.6	3	0.007
MC25EUM-L	2.8	22,600	0.7	2.2	3	6	0.3	2	0.020
MC25EUM	2.8	22,600	1.8	5.4	3	6	0.3	2	0.020
MC25EUM-H	2.8	22,600	4.6	13.6	3	6	0.3	2	0.020
MC30EUM-1	3.5	5,600	0.4	1.9	2	6	0.3	2	0.010
MC30EUM-2	3.5	5,600	1.8	5.4	2	6	0.3	2	0.010
MC30EUM-3	3.5	5,600	5	15	2	6	0.3	2	0.010
MC75EUM-1	9	28,200	0.3	1.1	4	9	0.3	2	0.035
MC75EUM-2	9	28,200	0.9	4.8	4	9	0.3	2	0.035
MC75EUM-3	9	28,200	2.7	36.2	4	9	0.3	2	0.035
MC75EUM-4	9	28,200	25	72	4	9	0.3	2	0.035

¹ If side load angle is higher contact ACE.

Technical data

Energy capacity: 0.68 Nm/cycle to 9 Nm/cycle

Impact velocity range: 0.15 m/s to 4 m/s (depending on type, see calculation of effective weight)

Operating temperature range: -10 °C to +66 °C

Mounting: in any position

Positive stop: integrated

Material: Outer body, accessories: Steel corrosion-resistant coating

Piston rod: Hardened stainless steel

Piston rod seal: NBR

Rod end button: Steel, MC25 and MC75: Elastomer insert

Locknut: Steel, MC5 and MC9: Aluminium

Permissible torque of locknut:

MC5: 1.3 Nm to 1.5 Nm

MC9: 1.3 Nm to 1.5 Nm

MC10: 1.3 Nm to 1.5 Nm

MC25: 4.0 Nm to 4.3 Nm

MC30: 4.0 Nm to 4.3 Nm

MC75: 5.0 Nm to 5.4 Nm

Damping medium: Special oil (data sheets on request)

Application field: Miniature slides, Pneumatic cylinders, Handling modules, Copiers, Measuring tables, Machines and plants, Locking systems

Note: If precise end position datum is required consider use of the stop collar type AH.

Safety instructions: External materials in the surrounding area can attack the sealing components and lead to a shorter service life. Please contact ACE for appropriate solution suggestions. Do not paint the shock absorbers due to heat emission.

On request: Increased corrosion protection. Special finishes. Models without rod end button.